

CIRCULATION PUMP

Circulation Pumps can be used in single pipe heating system, double pipe heating system, floor heating system, domestic hot water setback.

60Hz - Technical parameter

Model	Voltage	Frequency	Power	Current	Q Max.	H Max.	Size	Pump length
			W	Amp	m³/h	m	inch	mm
RS15/4-130EA	220V	60HZ	5-22	0.02-0.10	1.8	4	1"	130
RS25/4-130EA	220V	60HZ	5-22	0.02-0.10	2.6	4	1 1/2"	130
RS25/4-180EA	220V	60HZ	5-22	0.02-0.10	2.6	4	1 1/2"	180
RS32/4-180EA	220V	60HZ	5-22	0.02-0.10	3	4	2"	180
RS15/6-130EA	220V	60HZ	5-45	0.02-0.20	2.4	6	1"	130
RS25/6-130EA	220V	60HZ	5-45	0.02-0.20	3.6	6	1 1/2"	130
RS25/6-180EA	220V	60HZ	5-45	0.02-0.20	3.6	6	1 1/2"	180
RS32/6-180EA	220V	60HZ	5-45	0.02-0.20	3.6	6	2"	180
RS25/8-180EA	220V	60HZ	5-130	0.02-0.59	7.5	8	1 1/2"	180
RS32/8-180EA	220V	60HZ	5-130	0.02-0.59	10.2	8	2"	180

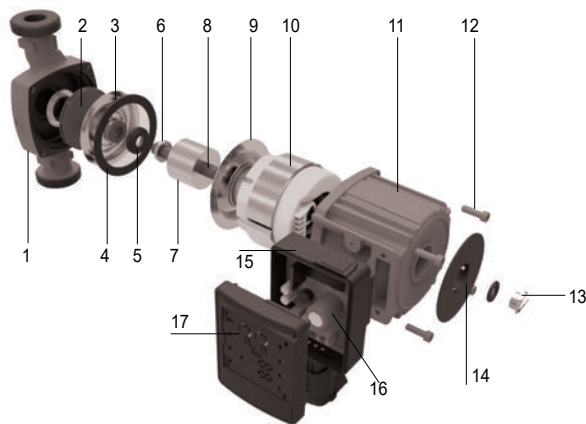
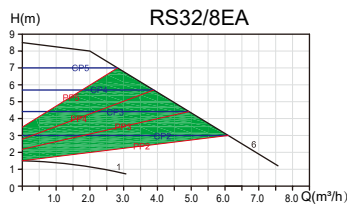
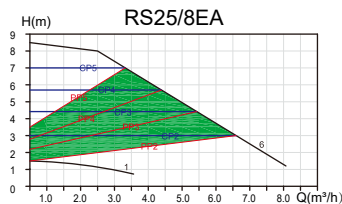
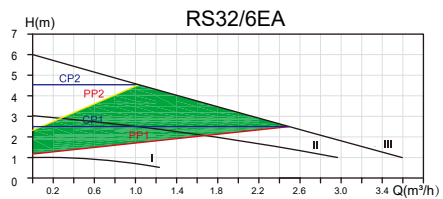
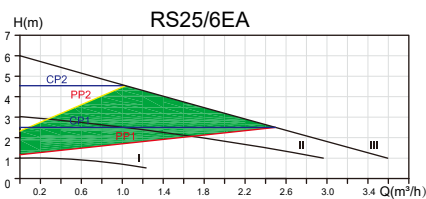
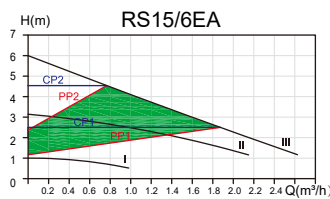
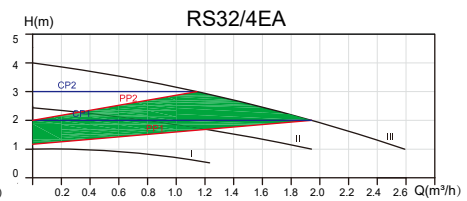
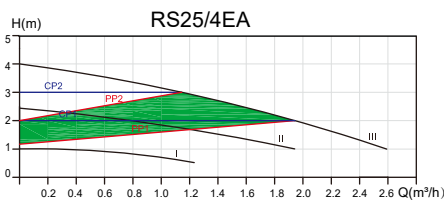
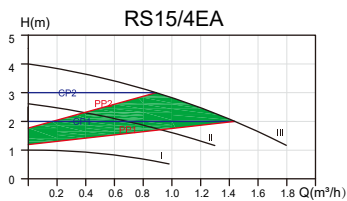

EXPLODED VIEW DRAWING - SPARE PARTS

No.	Description.	No.	Description.
1	Pump body	10	Stator
2	Impeller	11	Housing
3	Cover	12	Screw
4	Bearing	13	Screw
5	Gasket	14	Nameplate
6	Bearing	15	Seat of terminal box
7	Rotor	16	PCB
8	Shaft	17	Cover of terminal box
9	Cover		

available also in 50Hz